

AUTOMATIC CLIMATE CONTROL

107.045 INDEX

ACC Grounds Distribution.....	321
ACC Power Distribution.....	321
Air Delivery (Electrical).....	315
(Vacuum).....	317
Component Location Table.....	323
Component Mode Table.....	322
Compressor Clutch Control.....	320
Pushbutton Control Assembly....	301
Temperature Control.....	319

126.032/.033/.037/.043/ .044/.120 INDEX

ACC Grounds Distribution.....	309
ACC Power Distribution.....	309
Air Delivery (Electrical).....	302
(Vacuum).....	304
Component Location Table.....	311
Component Mode Table.....	310
Compressor Clutch Control (126.032/.033/.037/.043/.044).....	306
(126.120).....	307
Pushbutton Control Assembly....	301
Temperature Control.....	308

PUSHBUTTON CONTROL ASSEMBLY

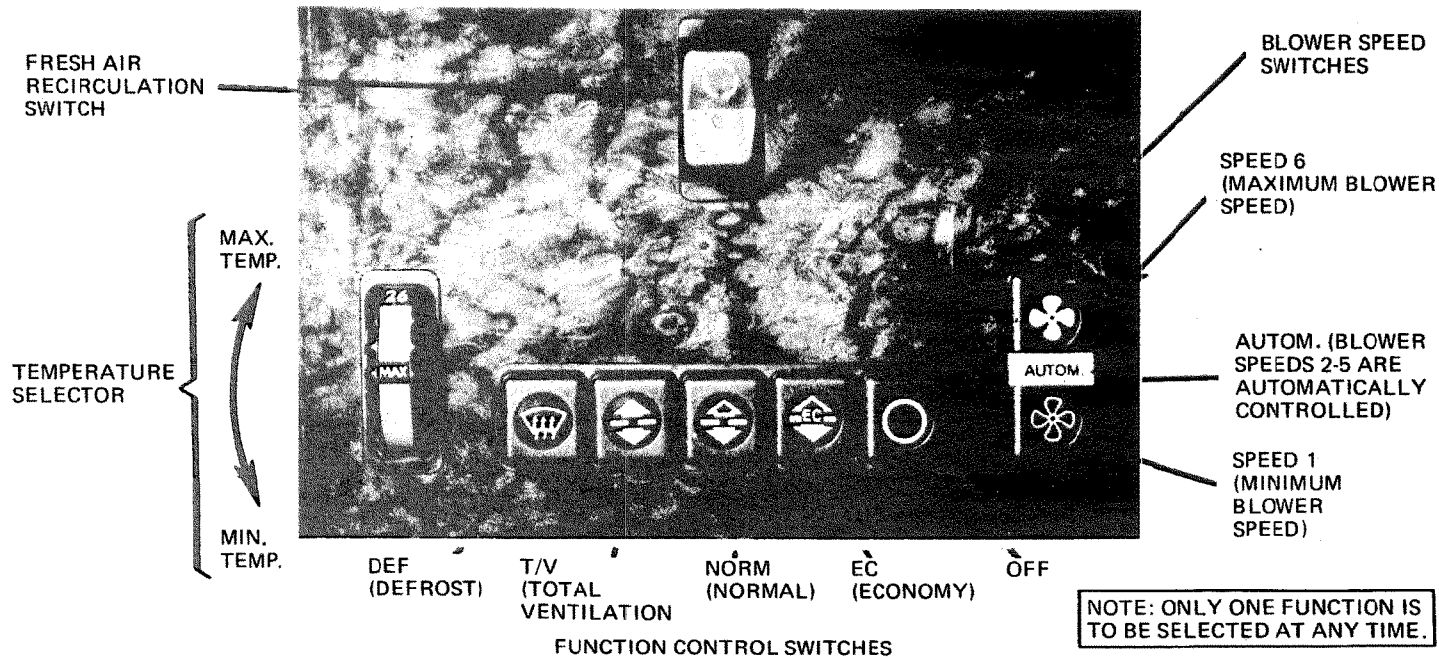

REVISIONS:

AIR DELIVERY (ELECTRICAL)

(For Component Locations See Page 311)

MY 1983/MY 1984/MY 1985

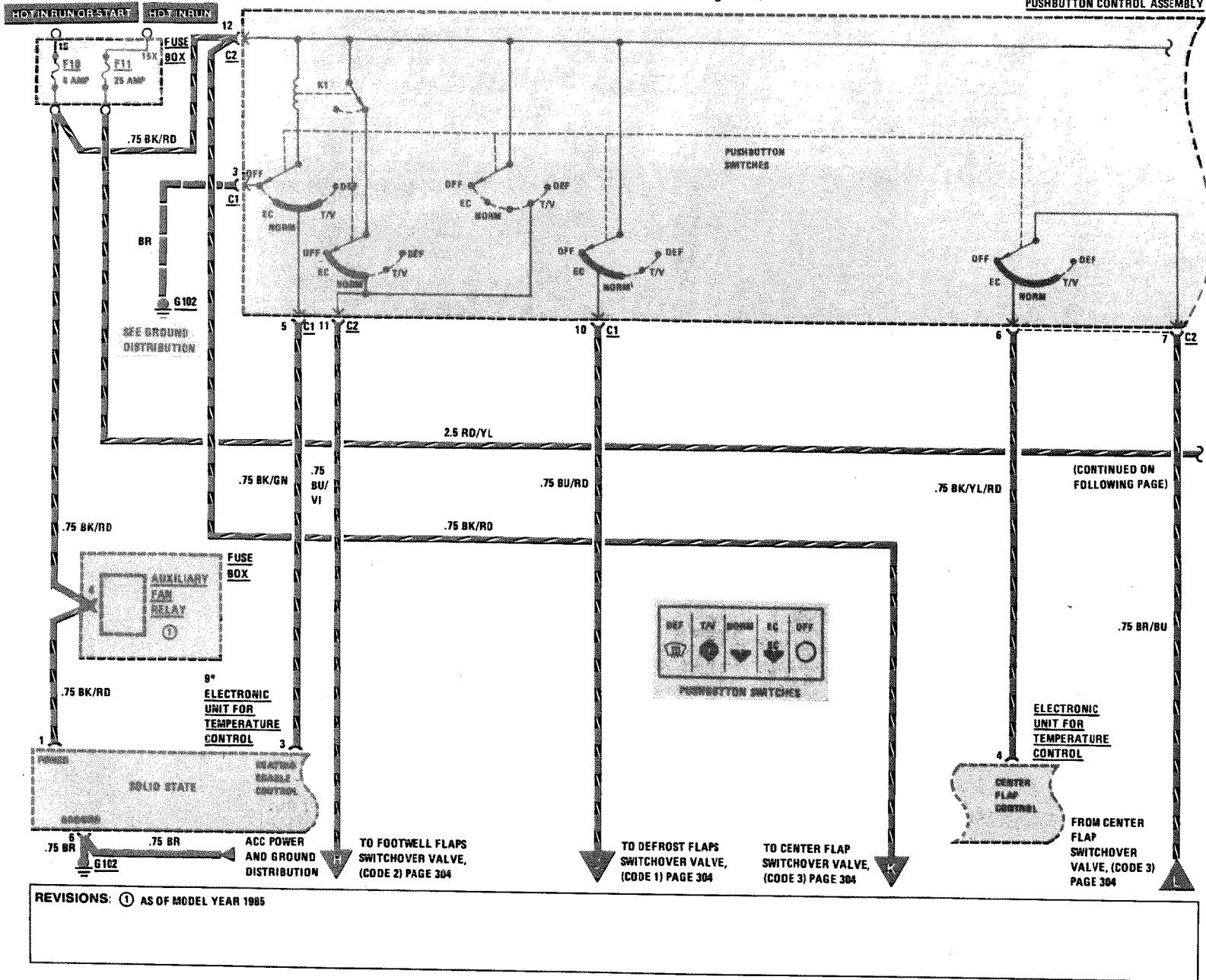

AIR DELIVERY (ELECTRICAL)

(For Component Locations See Page 311)

MY 1983/MY 1984/MY 1985

PUSHBUTTON CONTROL ASSEMBLY

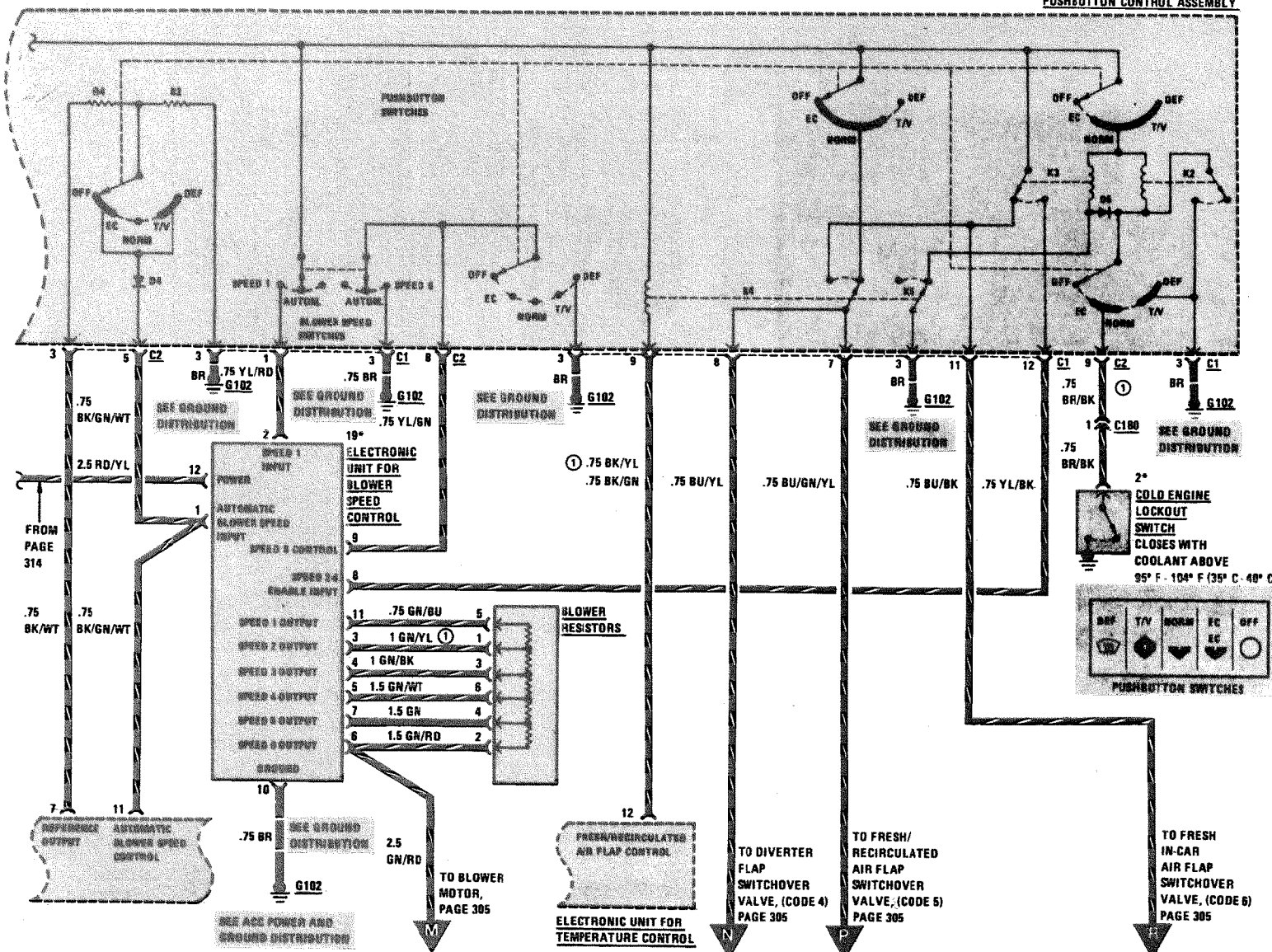

REVISIONS: ① AS OF MODEL YEAR 1985

1/87

126.032/.033/.037/.043/.044/.120

303

AIR DELIVERY (VACUUM)

(For Component Locations See Page 311)

MY 1983/MY 1984/MY 1985

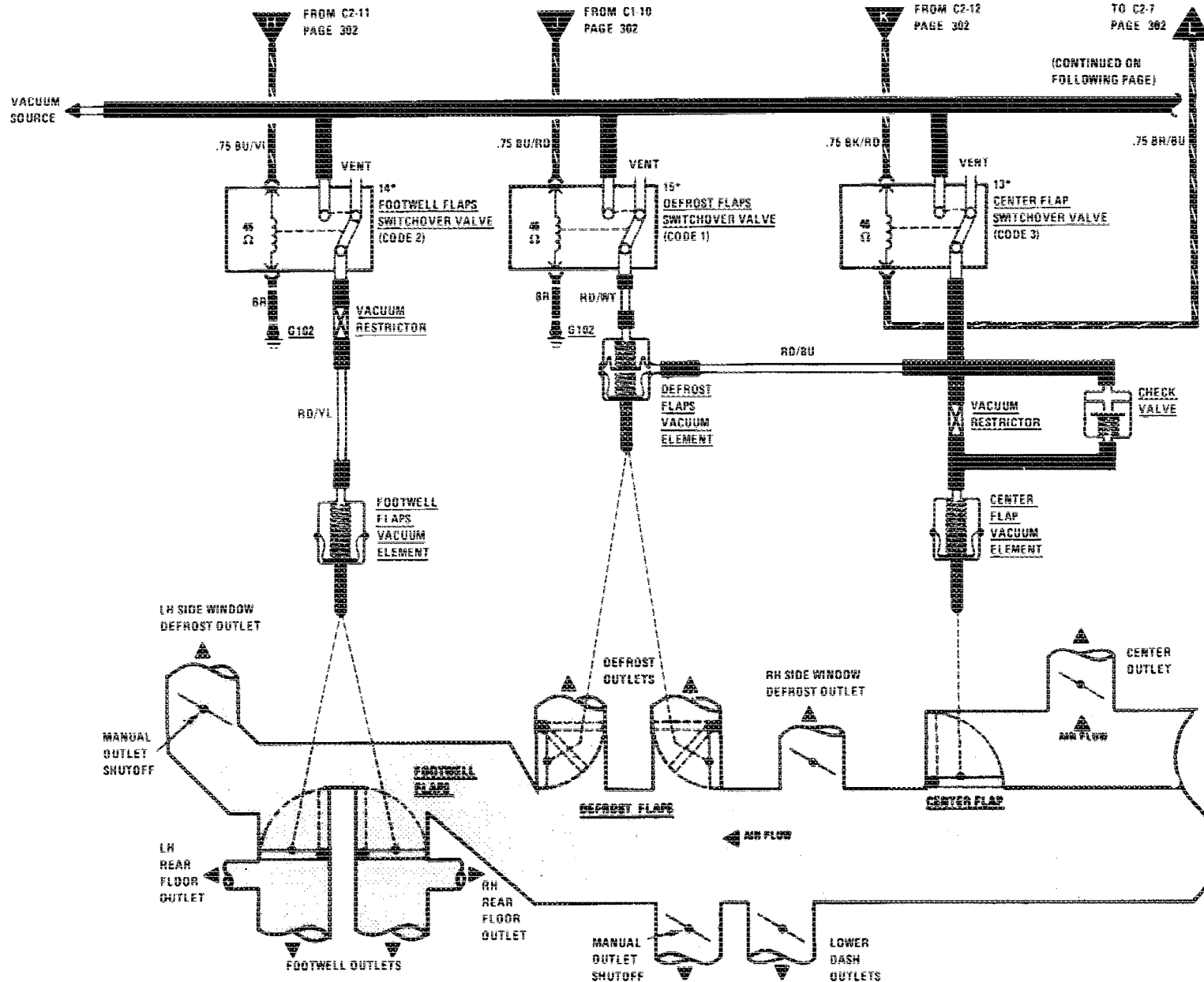

(CONTINUED ON FOLLOWING PAGE)

REVISIONS:

--	--	--

AIR DELIVERY (VACUUM)

MY 1983/MY 1984/MY 1985

(For Component Locations See Page 311)

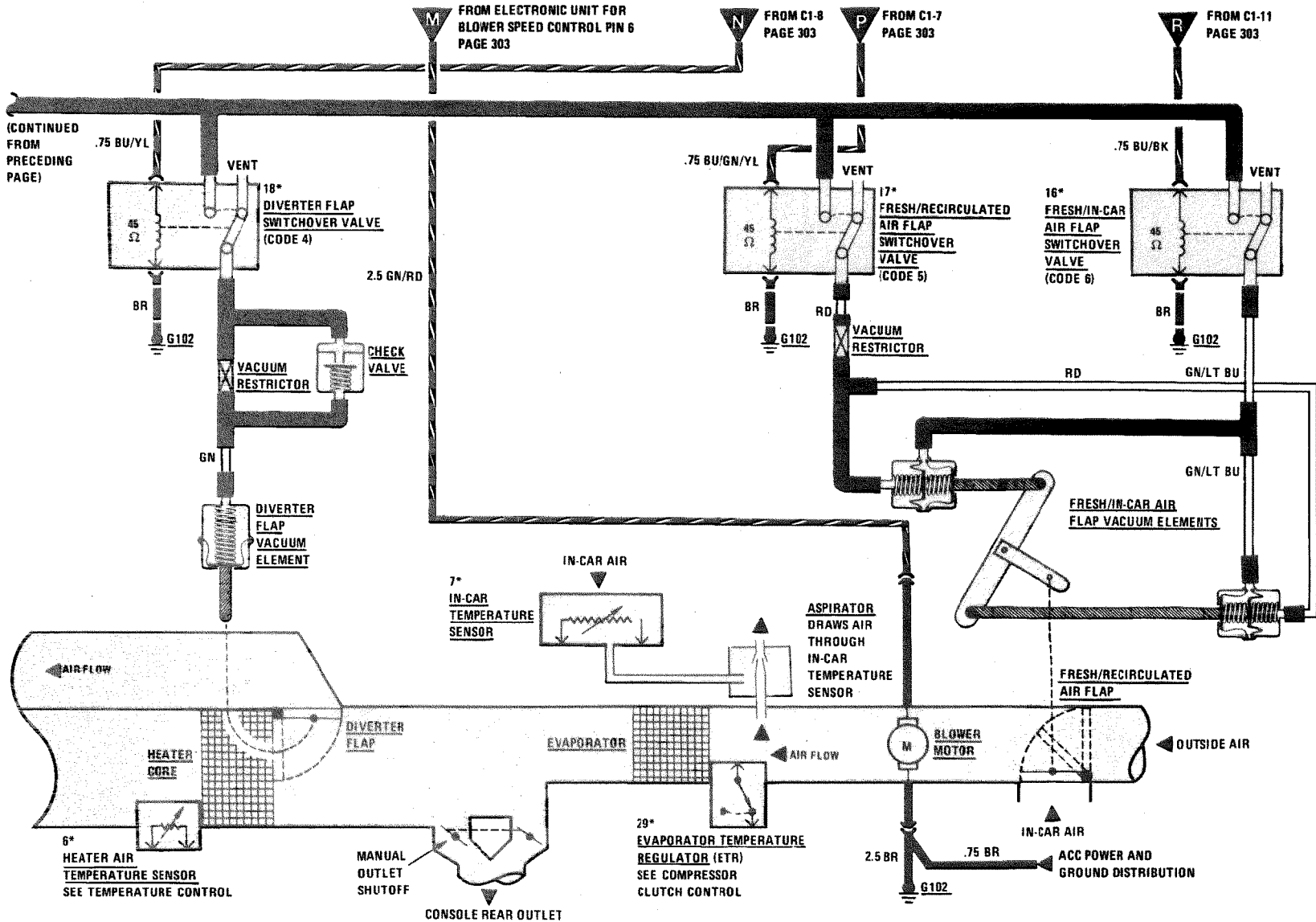

REVISIONS:

--	--	--

126.032/.033/.037/.043/.044/.120

COMPRESSOR CLUTCH CONTROL

(For Component Locations See Page 312)

MY 1983/MY 1984/MY 1985

380 SE/SEL/SEC, 500 SEL/SEC

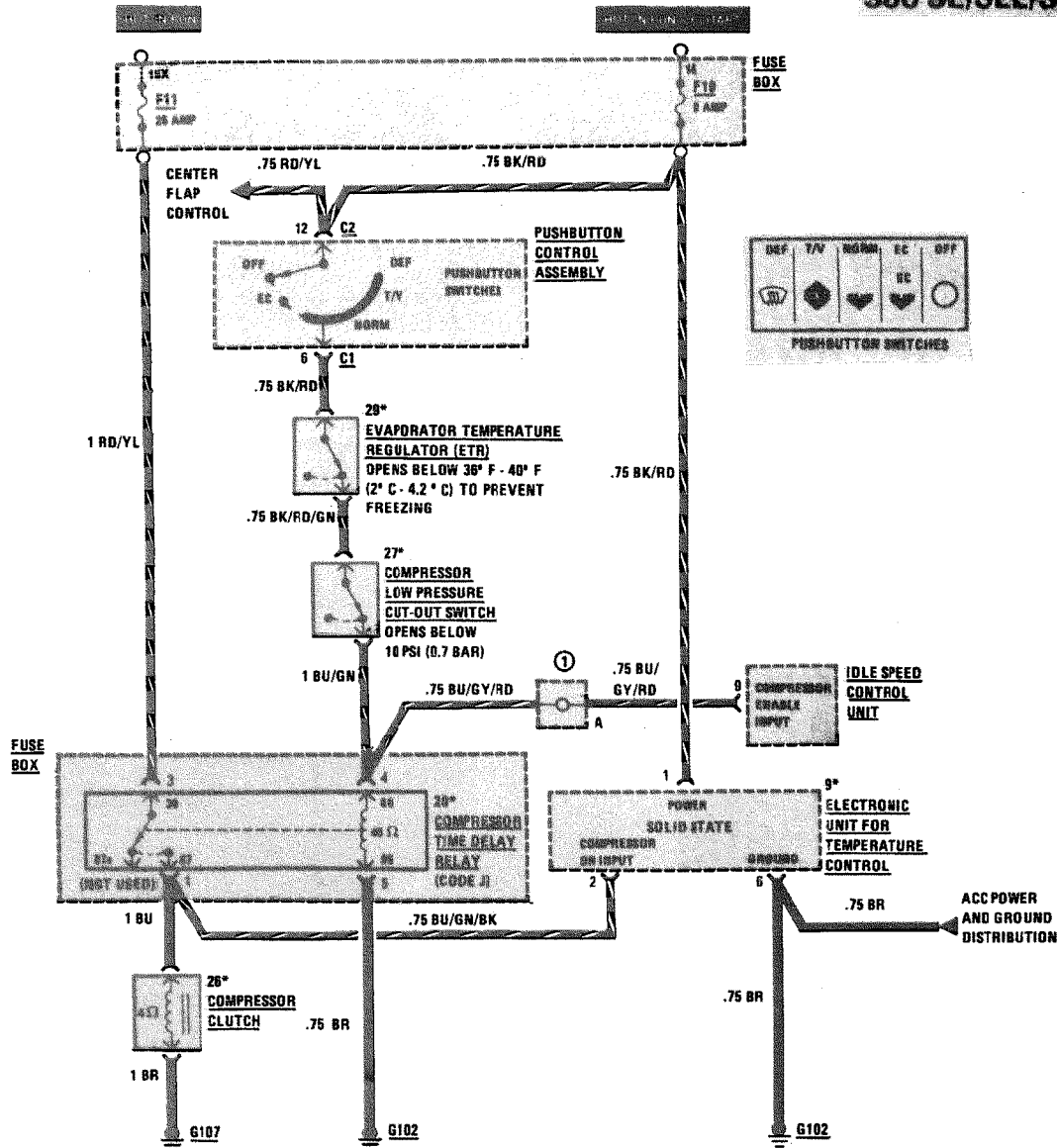

REVISIONS: ① AS OF MODEL YEAR 1985

COMPRESSOR CLUTCH CONTROL

(For Component Locations See Page 312)

MY 1983/MY 1984
300 SD

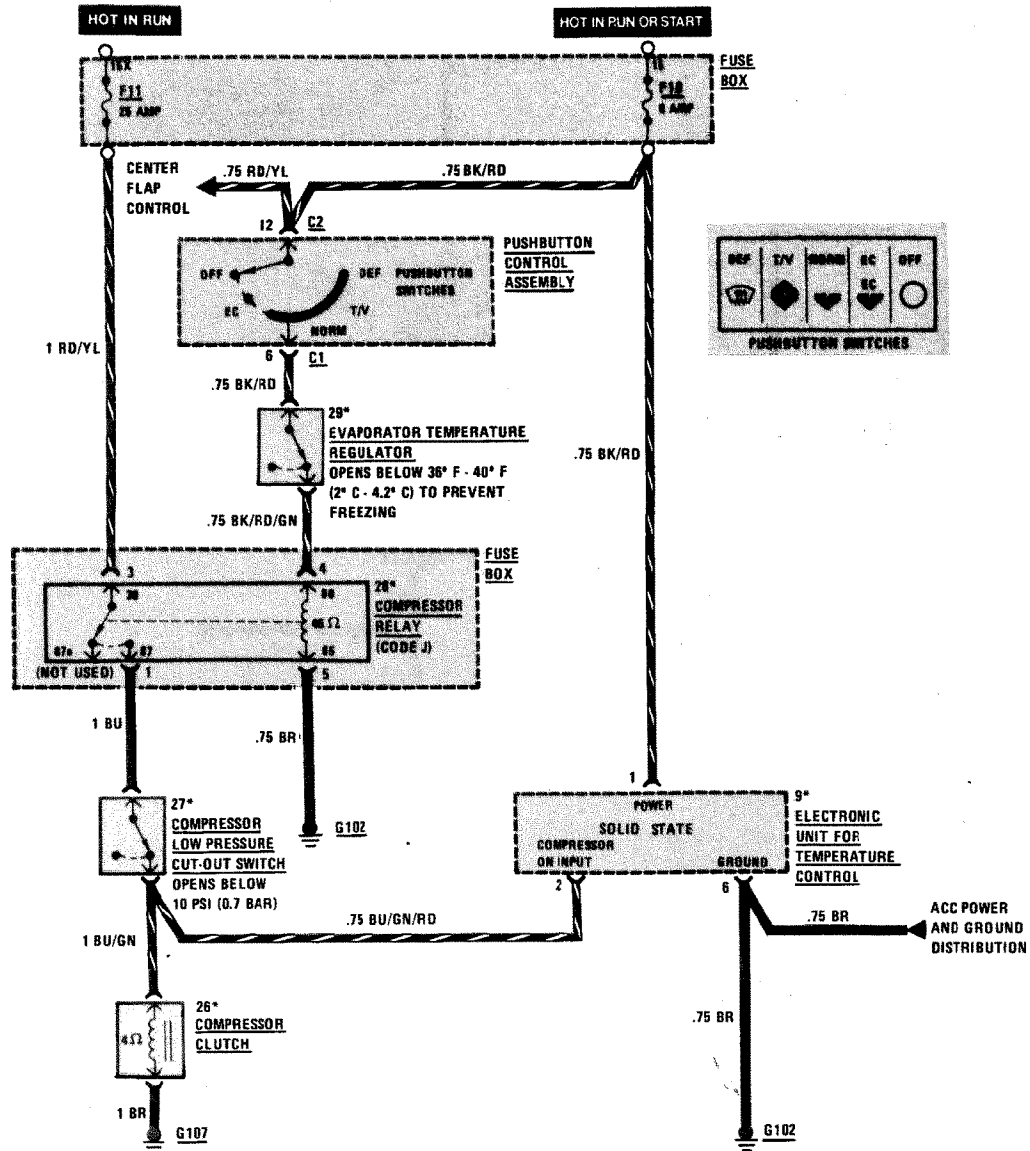

1/87

126.120

307

REVISIONS:

--

307/1

126.120

1/87

COMPRESSOR CLUTCH CONTROL

(For Component Locations See Page 312)

MY 1985

300 SD

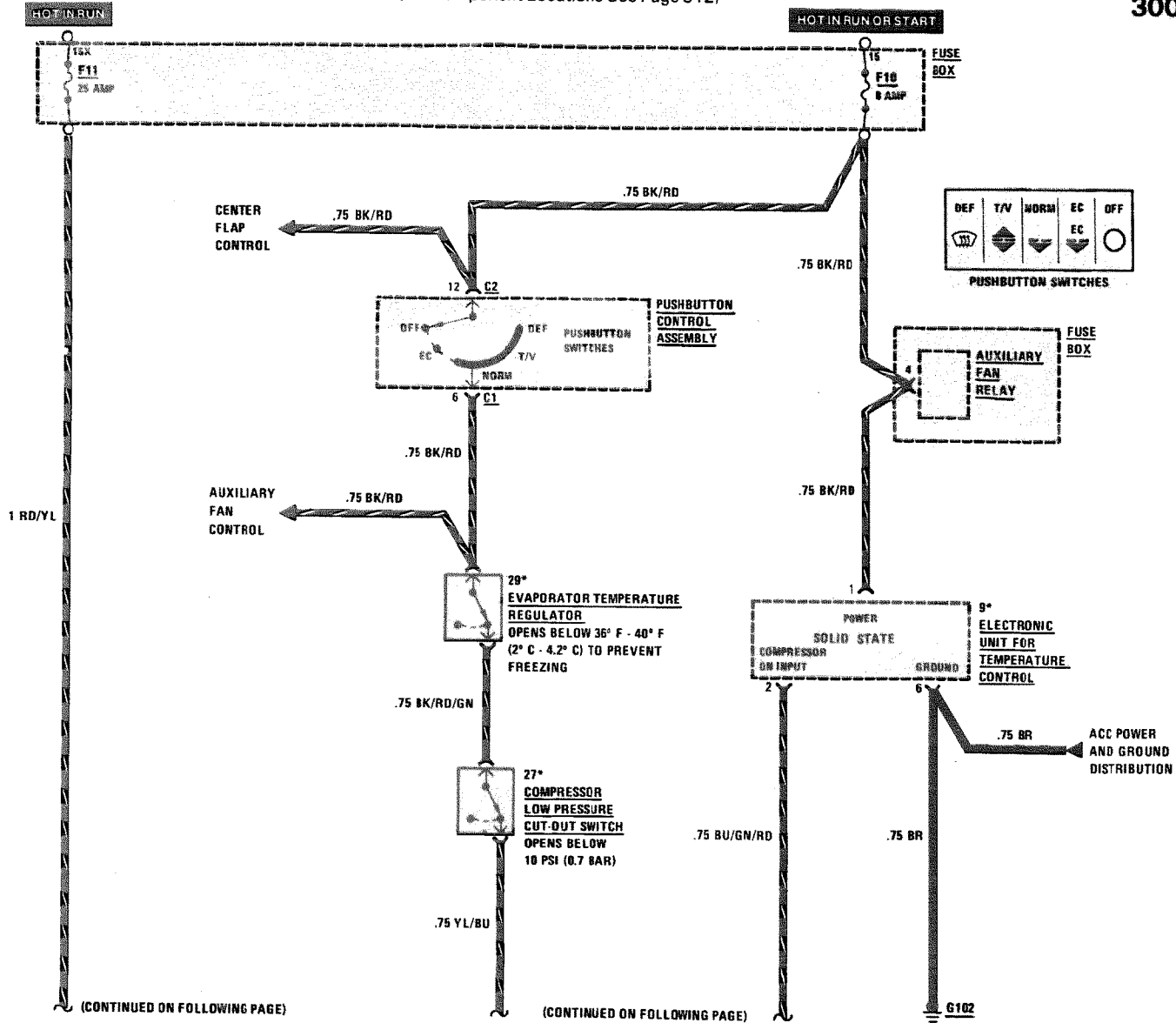

(CONTINUED ON FOLLOWING PAGE)

(CONTINUED ON FOLLOWING PAGE)

REVISIONS:

--	--	--

1/87

126.120

307/2

COMPRESSOR CLUTCH CONTROL

(For Component Locations See Page 312)

MY 1985 300 SD

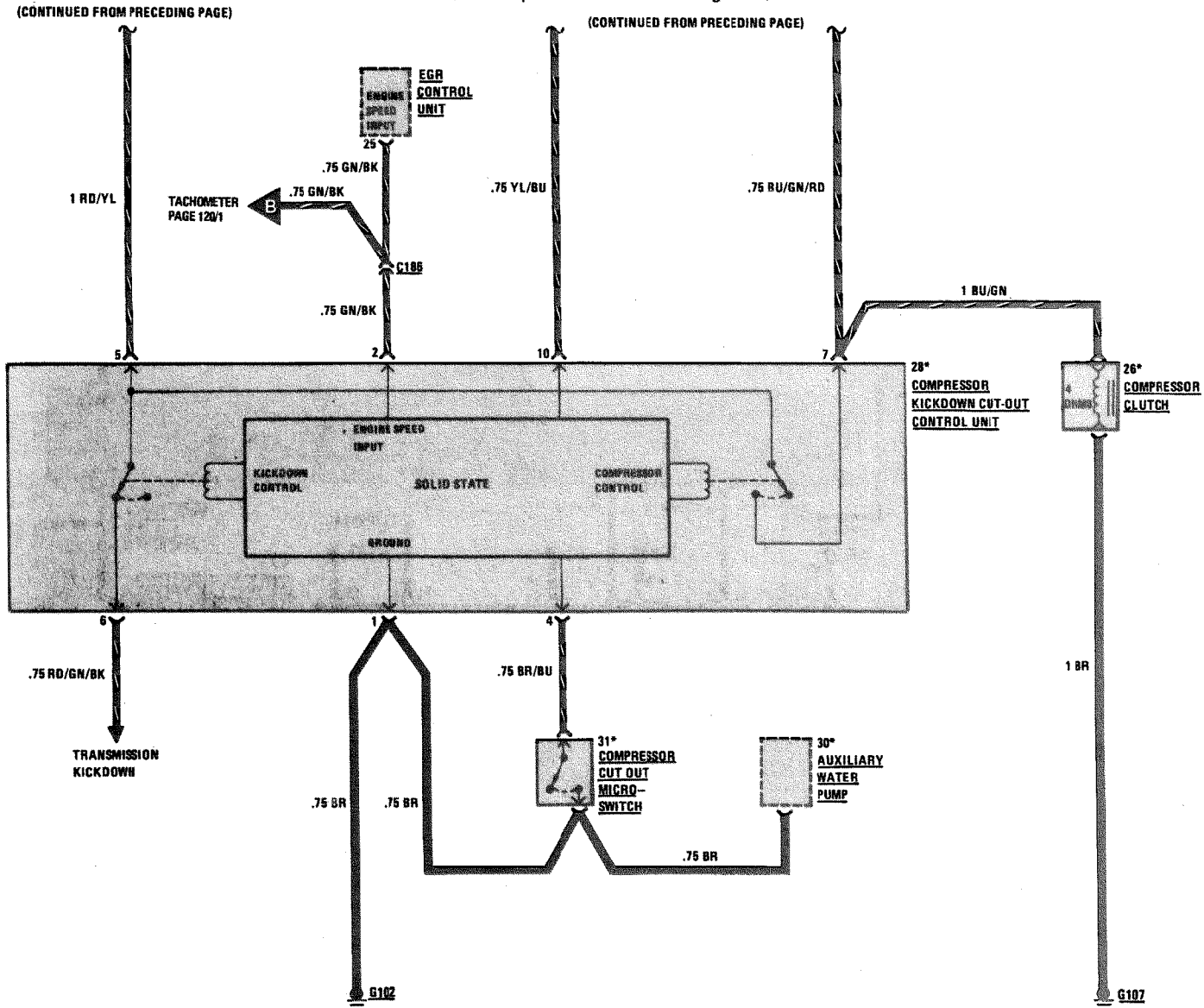

REVISIONS:

--

TEMPERATURE CONTROL

(For Component Locations See Page 313)

MY 1983/MY 1984/MY 1985

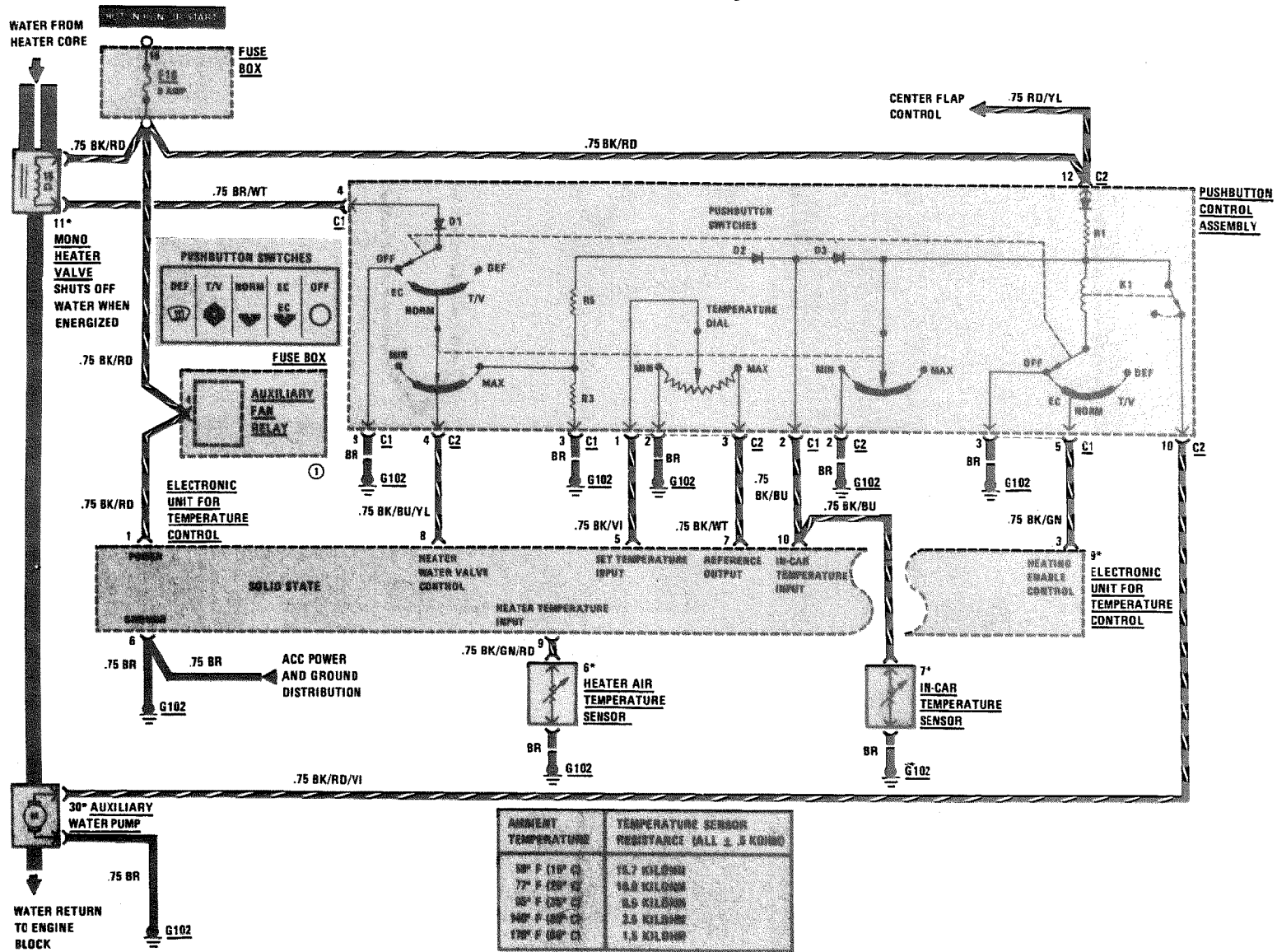

REVISIONS: ① AS OF MODEL YEAR 1985

AUTOMATIC CLIMATE CONTROL (ACC) POWER AND GROUND DISTRIBUTION

(For Component Locations See Page 311)

MY 1983/MY 1984/MY 1985

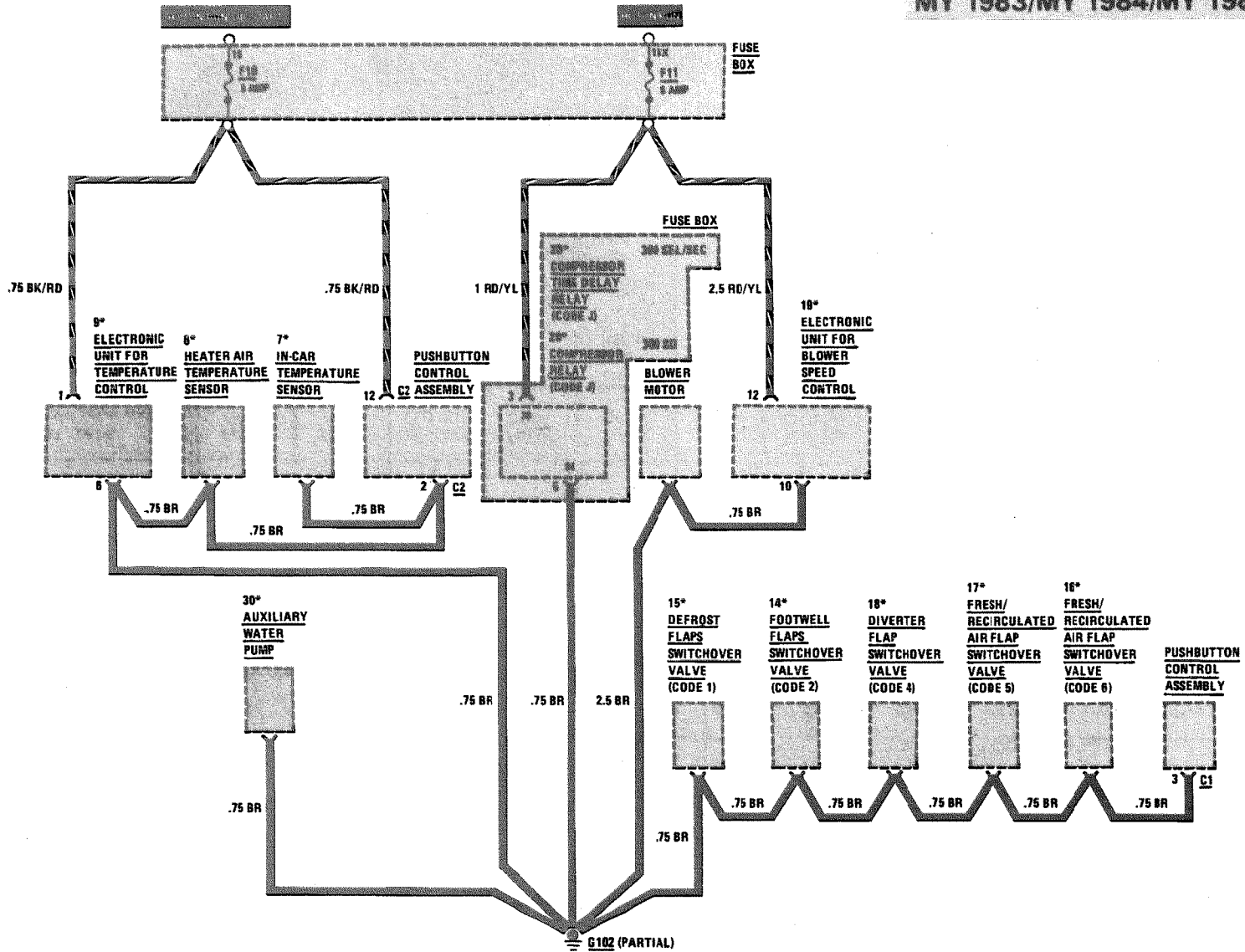

REVISIONS:

1/87

126.032/.033/.037/.043/.044/.120





309

COMPONENT MODE TABLE
300 SD, 380 SE/SEL/SEC, 500 SEL/SEC

MY 1983/MY 1984/MY 1985

310

126.032/.033/.037/.043/.044/.120

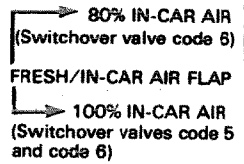
COMPONENTS	MODES											
	IGNITION	OFF 		TOTAL VENTILATION 			NORMAL 			ECONOMY 		DEFROST 
	OFF	(HEAT)	(COOL)	(HEAT)	(COOL)	(COOL at "MIN")	(HEAT)	(COOL)	(COOL at "MIN")	(HEAT)	(NO HEAT)	
HEATER WATER VALVE	OPEN	CLOSED	CLOSED	CYCLING	CLOSED	CLOSED	CYCLING	CLOSED	CLOSED	CYCLING	CLOSED	OPEN
AUXILIARY WATER PUMP	OFF	OFF	OFF	ON	OFF	OFF	ON	OFF	OFF	ON	OFF	ON
COMPRESSOR CLUTCH	OFF	OFF	OFF	ON	ON	ON	ON	ON	ON	OFF	OFF	ON
CENTER FLAP (Switchover valve code 3)	CLOSED	CLOSED	OPEN	CLOSED	OPEN	OPEN	CLOSED	OPEN	OPEN	CLOSED	OPEN	CLOSED
FOOTWELL FLAPS (Switchover valve code 2)	CLOSED	CLOSED	CLOSED	OPEN	OPEN	OPEN	OPEN	CLOSED	CLOSED	OPEN	CLOSED	CLOSED
DEFROST FLAPS (Switchover valve code 1)	FULLY OPEN	FULLY OPEN	ALMOST CLOSED	FULLY OPEN	FULLY OPEN	FULLY OPEN	ALMOST CLOSED	FULLY CLOSED	FULLY CLOSED	ALMOST CLOSED	FULLY CLOSED	FULLY OPEN
 80% IN-CAR AIR (Switchover valve code 6) FRESH/IN-CAR AIR FLAP 100% IN-CAR AIR (Switchover valves code 5 and code 6)	0% RECIRC	100% RECIRC	100% RECIRC	0% RECIRC	80% RECIRC	80% RECIRC	0% RECIRC	80% RECIRC	80% RECIRC	0% RECIRC	1. 80% RECIRC 2. 0% RECIRC	0% RECIRC
DIVERTER FLAP (Switchover flap code 4)	CLOSED	CLOSED	OPEN	CLOSED	OPEN	OPEN	CLOSED	OPEN	OPEN	CLOSED	OPEN	CLOSED

REVISIONS:

1/87

COMPONENT LOCATIONS

1/87

AIR DELIVERY (ELECTRICAL)

	Page-Figure
Blower Resistors	In blower control unit
Cold Engine Lockout Switch	Top RH front of engine 313-1
Electronic Unit For Blower Speed Control	Above passenger's footwell 314-5
Electronic Unit For Temperature Control	Above passenger's footwell 314-3
Fuse Box	LH rear corner of engine compartment 311-1
C180	On LH side of engine compartment 313-3
G102	Behind instrument cluster 313-4

AIR DELIVERY (VACUUM)

	Page-Figure
Aspirator	Right of glove box, behind dash
Center Flap Switchover Valve (Code 3)	In switchover valve group, third from top 314-1
Center Flap Vacuum Element	On plenum, behind pushbutton control assembly 314-1
Defrost Flaps Switchover Valve (Code 1)	In switchover valve group, top 314-1
Defrost Flaps Vacuum Element	On plenum, to right of center outlet 314-5
Diverter Flap Switchover Valve (Code 4)	In switchover valve group, fourth from top 314-1
Diverter Flap Vacuum Element	On LH side of plenum 314-2
Evaporator Temperature Regulator	LH side of plenum, above driver's footwell 314-2
Footwell Flaps Switchover Valve (Code 2)	In switchover valve group, second from top 314-1
Footwell Flaps Vacuum Element	On plenum, behind pushbutton control assembly 314-1
Fresh/In-Car Air Flap Vacuum Elements	On plenum, to right of center outlet 314-5
Fresh/In-Car Air Switchover Valve (Code 6)	In switchover valve group, bottom 314-1
Fresh/Recirculated Air Flap Switchover Valve (Code 5)	In switchover valve group, fifth from top 314-1
Fuse Box	LH rear corner of engine compartment 311-1
Heater Air Temperature Sensor	In heater housing, behind console
In Car Temperature Sensor	Top of dash panel
Vacuum Restrictor	RH side of console, by switchover valve group 314-1
G102	Behind instrument cluster 313-4

AUTOMATIC CLIMATE CONTROL (ACC) POWER AND GROUND

DISTRIBUTION

	Page-Figure
Auxiliary Water Pump	Under heater water valve 311-2
Blower Motor	Part of blower control unit 314-3
Defrost Flaps Switchover Valve (Code 1)	In switchover valve group, top 314-1
Diverter Flap Switchover Valve (Code 4)	In switchover valve group, fourth from top 314-1

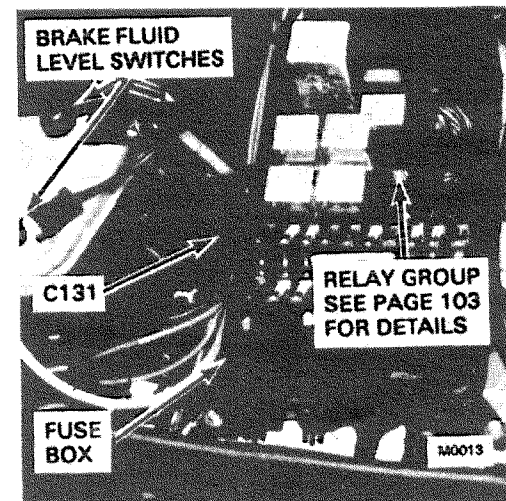

Figure 1 – LH Rear Corner of Engine Compartment

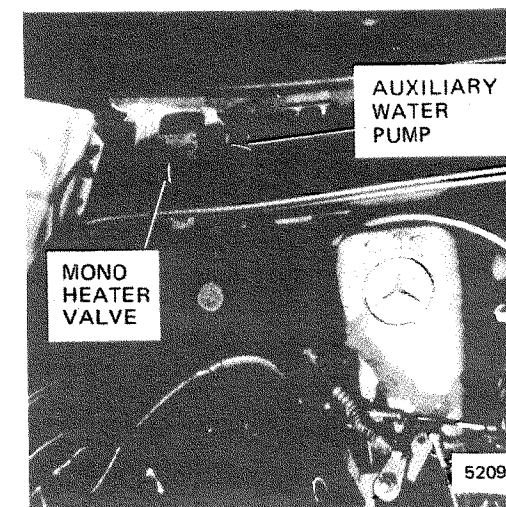

Figure 2 – RH Rear of Engine Compartment

REVISIONS:

--

126.032/.033/.037/.043/.044/.120

COMPONENT LOCATIONS

AUTOMATIC CLIMATE CONTROL (ACC) POWER AND GROUND DISTRIBUTION (Continued)

	Page-Figure
Electronic Unit For Blower Speed Control	
..... Above passenger's footwell	314-5
Electronic Unit For Temperature Control	
..... Above passenger's footwell	314-3
Footwell Flaps Switchover Valve (Code 2)	
..... In switchover valve group, second from top	314-1
Fresh/Recirculated Air Flap Switchover Valve (Code 5)	
..... In switchover valve group, fifth from top	314-1
Fuse Box	
..... LH rear corner of engine compartment	311-1
Heater Air Temperature Sensor	
..... In heater housing, behind console	
In Car Temperature Sensor	
..... Top of dash panel	
G102	
..... Behind instrument cluster	313-4

COMPRESSOR CLUTCH CONTROL

	Page-Figure
Auxiliary Water Pump	
..... Under heater water valve	311-2
Compressor Clutch	
..... Front of compressor	
Compressor Cut-Out Micro Switch	
..... Top of valve cover	
Compressor Kickdown Cut-Out Control Unit	
..... Center rear of engine compartment	
Compressor Low Pressure Cut-Out Switch	
..... Behind LH headlight	312-1
EGR Control Unit	
..... Behind RH kick panel	314-4
Electronic Unit For Temperature Control	
..... Above passenger's footwell	314-3
Evaporator Temperature Regulator	
..... LH side of plenum, above driver's footwell	314-2
Fuse Box	
..... LH rear corner of engine compartment	311-1
Idle Speed Control Unit	
..... Rear center of engine compartment	312-2
C186 (1 pin)	
..... Behind instrument cluster	
G102	
..... Behind instrument cluster	313-4
G107	
..... Behind LH headlights	313-2

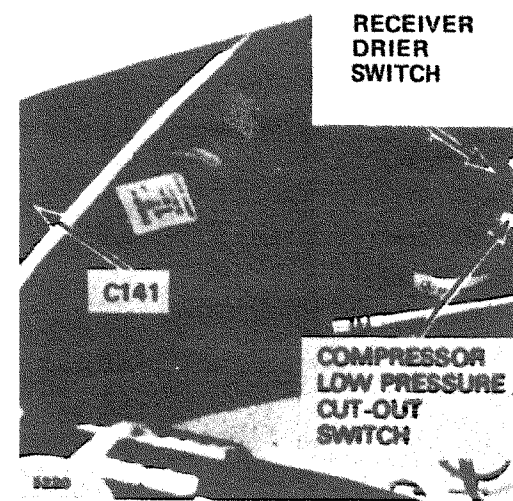

Figure 1 — Behind LH Headlights

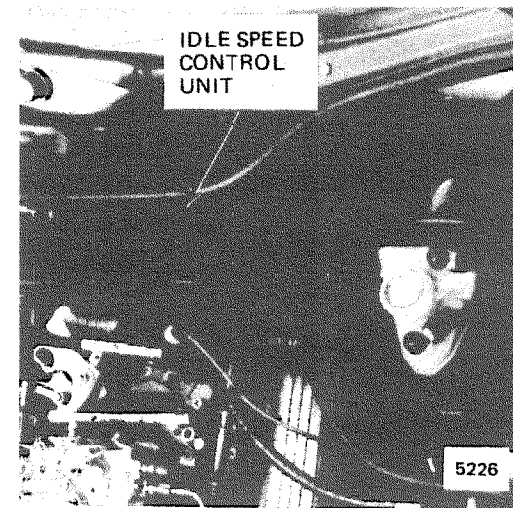

Figure 2 — Rear Center of Engine Compartment

REVISIONS:

COMPONENT LOCATIONS

TEMPERATURE CONTROL

		Page-Figure
Auxiliary Water Pump	Under heater water valve	311-2
Electronic Unit For Temperature Control	Above passenger's footwell	314-3
Fuse Box	LH rear corner of engine compartment	311-1
Heater Air Temperature Sensor	In heater housing, behind console	
In Car Temperature Sensor	Top of dash panel	
Mono Heater Valve	To left of battery	311-2
G102	Behind instrument cluster	313-4

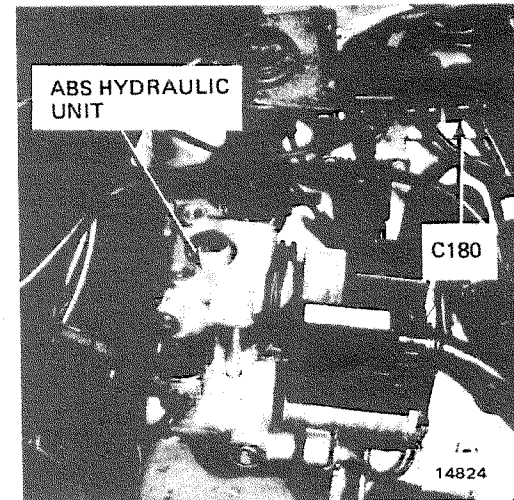

Figure 3 — LH Side of Engine Compartment

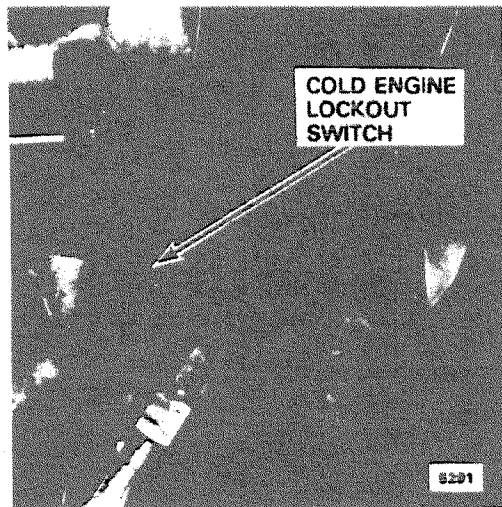

Figure 1 — Front RH Side of Engine

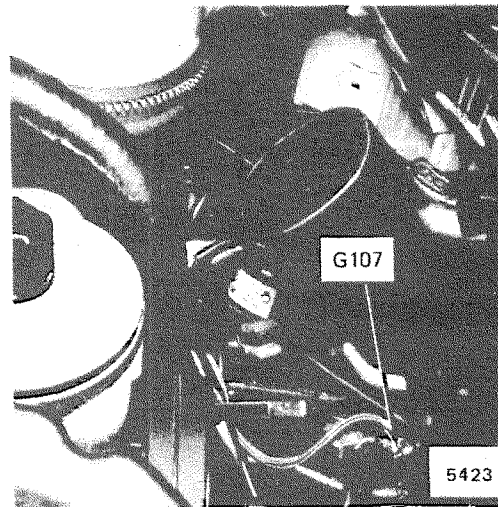

Figure 2 — Behind LH Headlight

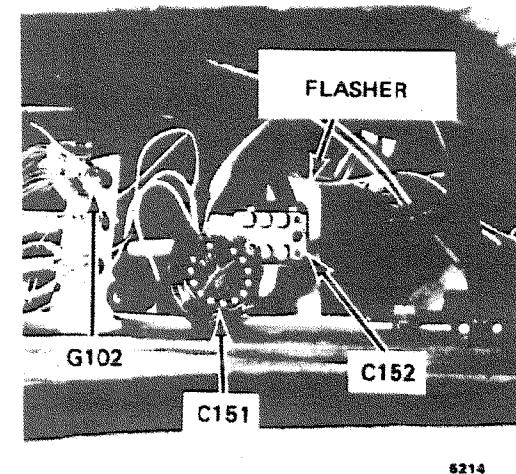

Figure 4 — Behind Instrument Cluster

REVISIONS:

--	--

COMPONENT LOCATIONS

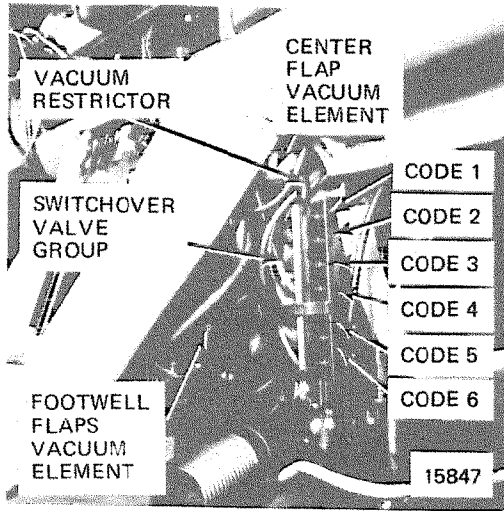

Figure 1 - In Console, Behind Pushbutton Control Assembly

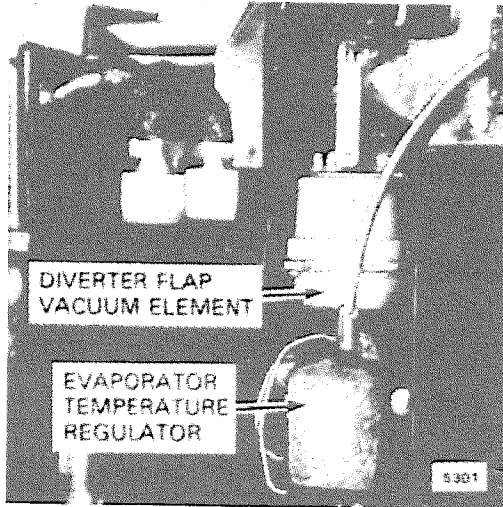

Figure 2 - RH Side of Plenum, Above Passenger's Footwell

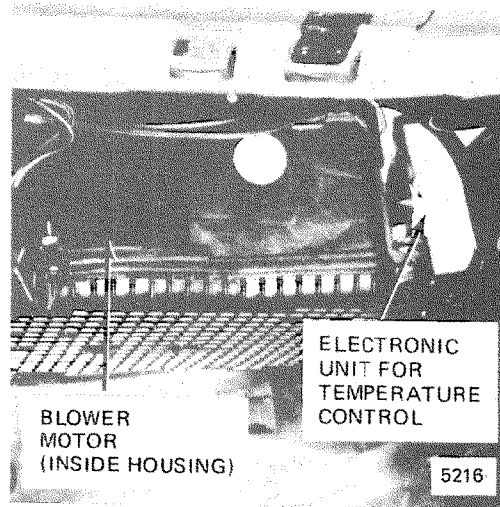

Figure 3 - Passenger's Footwell

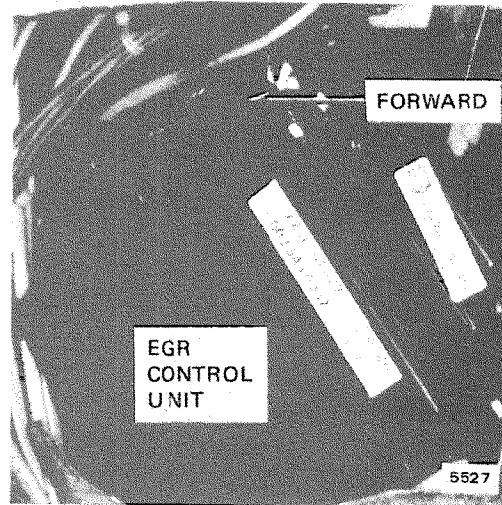

Figure 4 - Behind RH Kick Panel

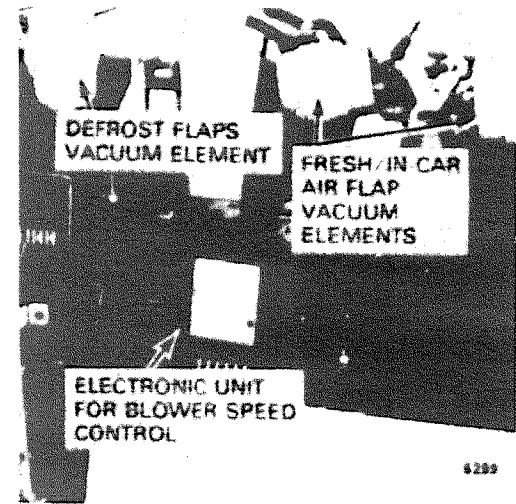

Figure 5 - Behind Glove Box

REVISIONS:

--